

### OPERATIONAL MANUAL

- 1 Twist counter clockwise to remove the bottom chamber cover.
- 2 Fill the chamber with ground material of your choice.

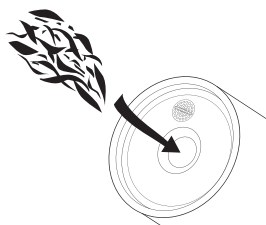

- 3 Twist the bottom chamber cover clockwise until it is tightened and secured.
- 4 Twist counter clockwise to remove both the borosilicate glass mouthpiece and the aluminum anti-leak top cover.

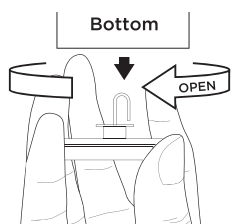
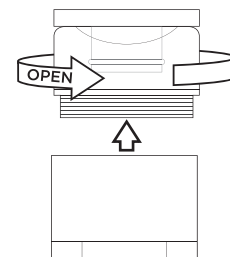
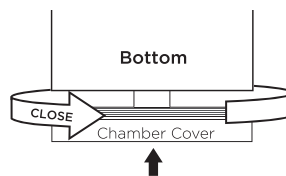

- 5 Fill the top opening with liquid to the desirable level. It is recommended not to fill in excess of 70% of the water chamber.
- 7 Press the circular operational button quickly three times in Power OFF mode to turn power to ON mode.

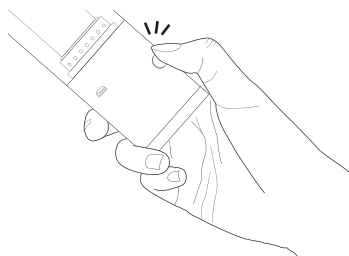

- 8 When the power is ON, every single press to the circular operational button will rotate through the five available temperature settings.

At the desired temperature, simply wait for the flashing light to turn solid green to enter inhalation session.

- 9 During the inhalation session, the previously specified temperature will be maintained for **120 seconds**. It will then enter standby mode for **60 seconds**, which is represented by a solid light blue glow. This completes a single session.

To start another session, press the circular operational button once to re-enter the temperature selection rotation. Repeat step 8.

- 6 Twist clockwise to remount the glass mouthpiece.

### LED Light Color Indications

#### Flashing Blue

Heating towards 1st degree (Lowest temperature)

#### Flashing Yellow

Heating towards 2nd degree

#### Flashing Orange

Heating towards 3rd degree

#### Flashing Purple

Heating towards 4th degree

#### Flashing Red

Heating towards 5th degree (Highest temperature)

#### Solid Green

Ready for inhalation. (Desired temperature reached)

- 10 During session, twist the bottom stir knob for a more even heat distribution. We recommend pausing for 5-10 seconds between each hit to allow chamber temperature to recover.

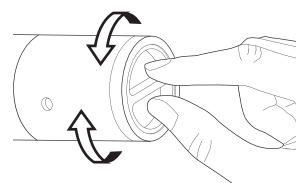

- 11 Press the circular operational button quickly three times in POWER ON mode to turn power to OFF mode.
- 12 The device will automatically power-off after being idle for **10 minutes**.

### Battery Life Display

When device is powered off, press and hold the circular operational button for 3 seconds.

Full - Green Light

Half - Blue Light

Low - Red Light

### Battery Charging

Connect the included Micro-USB cable to the device and insert USB connector to the AC adapter. Plug the AC adapter into an electrical outlet.

LED will flash red 3 times as charging begins.

**Solid Red = Charging in progress**

**Solid Green = Charging completed**

9

## QUICK MAINTENANCE

1 Twist counter clockwise to remove the borosilicate glass mouthpiece.

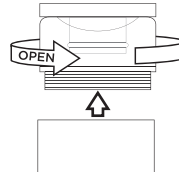

2 Fill the device with clean water and shake it while covering it with the top of your hand for a quick cleaning of the water chamber.

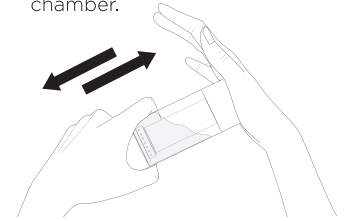

10

3 Use the short cleaning brush to clean the air intake, heating chamber and the interior air duct.

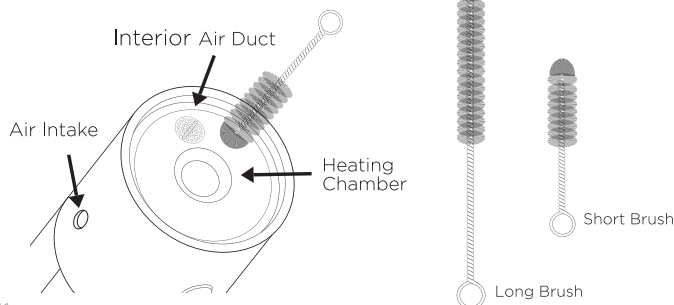

11

### Air Flow Improvement

Use the included residue pick to clear any clogged passages on the bottom stir and the interior air duct.

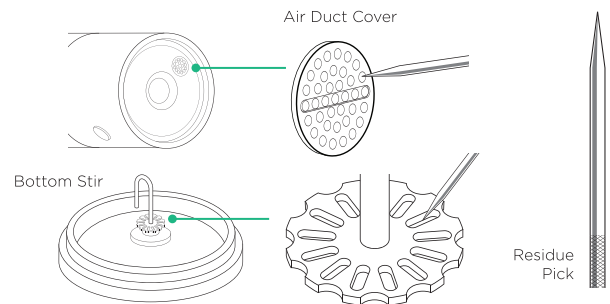

12

## IN-DEPTH MAINTENANCE

### Glass Water Chamber

Hold the top and bottom aluminum body and twist the top aluminum counter clockwise and the bottom aluminum clockwise. You will notice the glass chamber will begin to loosen, proceed to unscrew the top aluminum body counter clockwise entirely.

Loosen

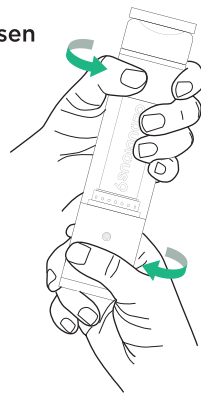

13

Disassemble the top aluminum body, glass chamber and the bottom aluminum unit. Wash glass chamber gently with running water.

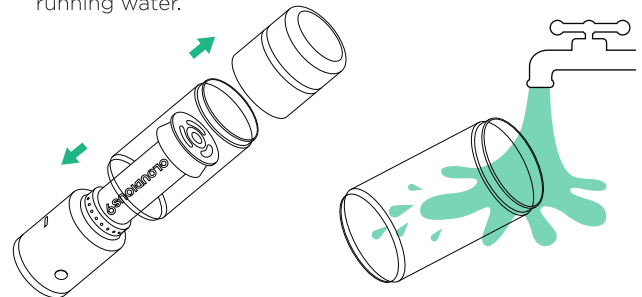

14

### Water Tunnel

Water tunnel does not need to be cleaned frequently. However if necessary, you can clean the water tunnel by first removing the silicone cover at the top of the water tunnel.

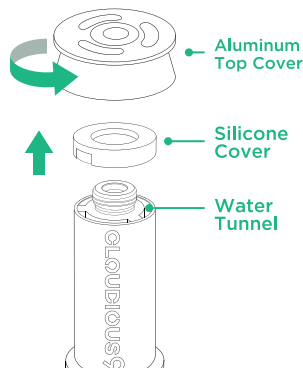

15

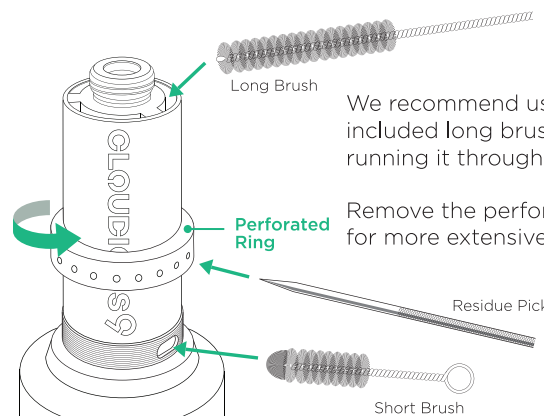

We recommend using the included long brush and running it through each tunnel.

Remove the perforated ring for more extensive cleaning.

16

## Interior Air Duct

Unscrew the interior air duct cover located next to the chamber with the included flathead screwdriver. We recommend using the included long brush for interior air duct cleaning.

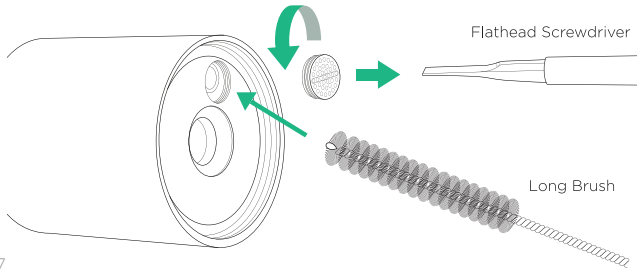

17

## LED LIGHT VISUAL EFFECTS

For visual purposes only

### LED Light Rotation Mode

When Hydrology9 is powered on, but **not in operation**, press and hold the circular operation button for three seconds to start the random LED light rotation mode. Hold and press for three seconds to exit.

### LED Light Flashing Mode

When Hydrology9 **is in operation**, such as during the heating process, press and hold the circular operation button for three seconds to begin the LED light flashing mode. Hold and press for three seconds to exit.

18

## WARNING

Hydrology9 is leak resistant, but the following actions will cause liquid contained inside the liquid chamber to spill or leak.

1. Air pressure directed into the device's water chamber will cause water to leak from the bottom.
2. Do not shake or turn the device 360 degrees multiple times. This may void the water resistant design and cause minor leakage.



19

## Seam Leakage

If you experience leakage from the seam between the glass water chamber and the aluminum base, it simply means the glass chamber needs to be slightly tightened.

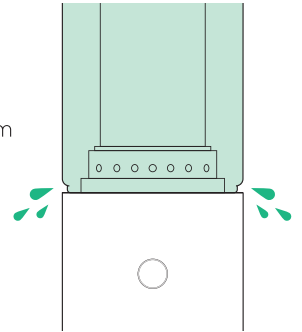

20

## Tighten



Hold the top and bottom aluminum body and **VERY** lightly twist the top aluminum clockwise and the bottom aluminum counter clockwise.

Do not apply too much pressure as it will damage the glass chamber.

21

**Stop using Hydrology9** if the battery tube inside the water chamber is disconnected from the bottom base. If this occurs, contact customer service immediately for further assistance.

### In case of a leak, stop using Hydrology9 immediately.

Towel dry the device, then allow it to naturally dry completely before using. The electronic portion of Hydrology9 is designed to be shielded from any water exposure.

22

For more detail on Hydrology9 Warranty Terms and Conditions please visit :  
<http://www.cloudious9.com/warranty/>

**CLOUDIOUS9®**  
WWW.CLOUDIOUS9.COM

© 2017 Cloudious9 Inc. All rights reserved.  
Cloudious9® is a registered trademark of Cloudious9 Inc.  
Hydrology9™ is a trademark of Cloudious9 Inc.

23



[MagicVaporizers](#) – Europe's Best Shop for Vaporizers

- Lowest prices
- Fastest shipping
- Most trusted warranty

